

IMU

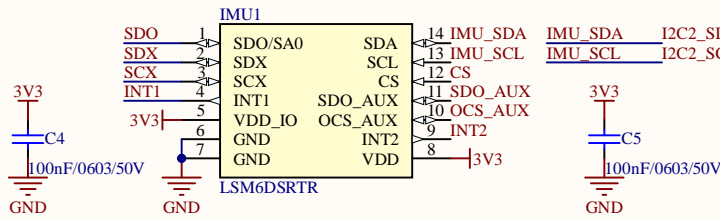

LDO

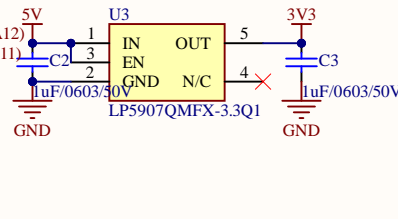

Connect

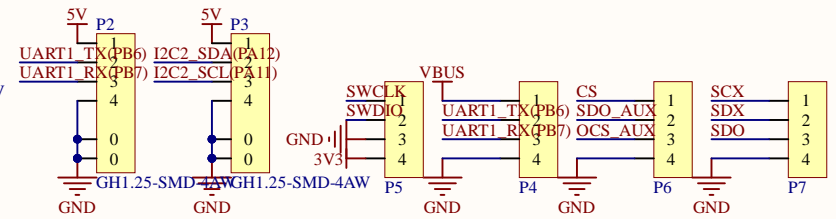

MCU

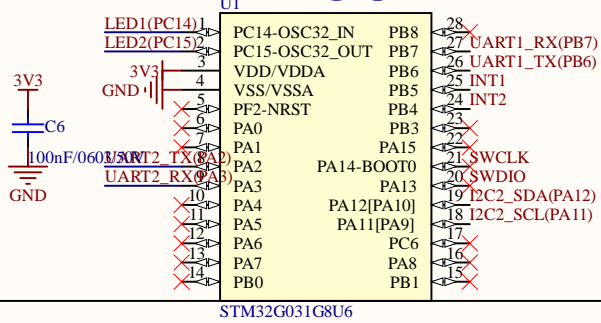

State

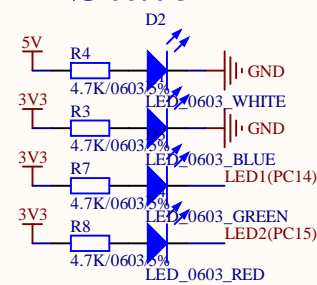

USB

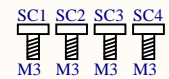
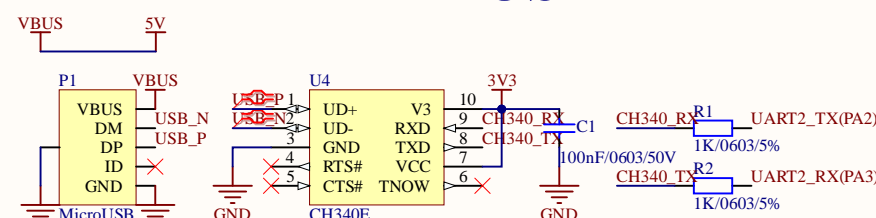

Title			HWSD-SNSR Series-Gyroscope		
Size	Number	Revision		V3.0	
A4					
Date:	4/11/2022	Sheet of			
File:	C:\Users\...HWSD-Gyroscope V3.0.SchDoc	Drawn By:	ASR-Crash		